

Power Integrated Module (PIM)

■ Features

- Included Rectifier and Brake Chopper
- Square RBSOA
- Low Saturation Voltage
- Overcurrent Limiting Function
(~ 3 Times Rated Current)

■ Equivalent Circuit

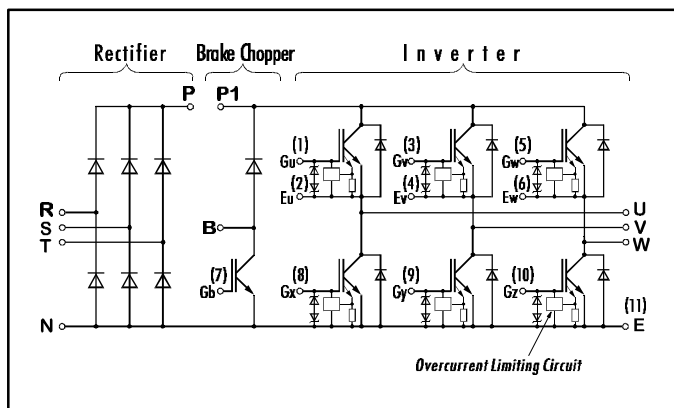

■ Outline Drawing

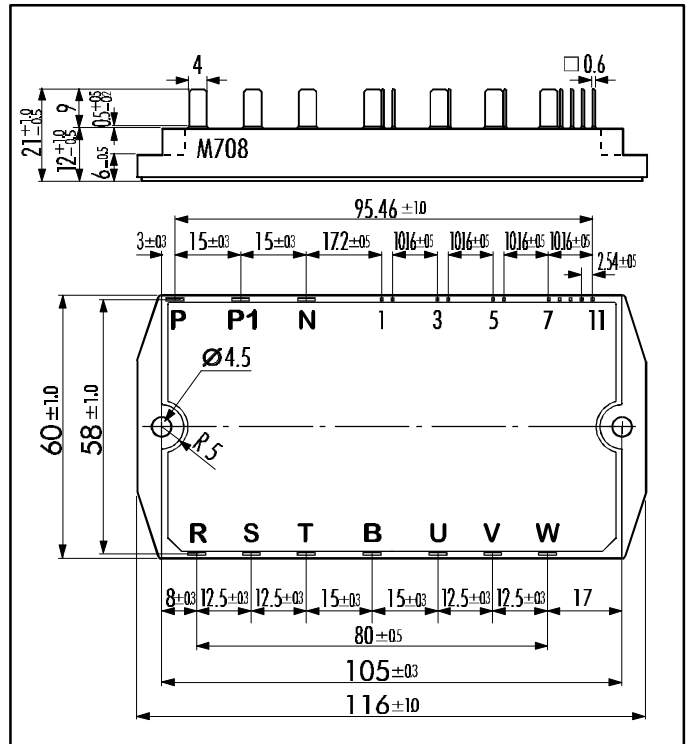

■ Absolute Maximum Ratings (T_c=25°C)

Items		Symbols	Test Conditions	Ratings	Units
Inverter	Collector-Emitter Voltage	V _{CES}		600	V
	Gate -Emitter Voltage	V _{GES}		± 20	
	Collector Current	I _C	Continuous	50	A
		I _{C PULSE}	1ms	100	
		-I _{C PULSE}	1ms	50	
Collector Power Dissipation	P _C	1 device	200	W	
Rectifier	Repetitive Peak Reverse Voltage	V _{RRM}		800	V
	Non Repetitive Peak Reverse Voltage	V _{RSM}		900	
	Average Output Current	I _O	50Hz/60Hz sin. wave	50	A
	Surge Current (Non Repetitive)	I _{FSM}	T _j =150°C, 10ms	350	
	I ² t (Non Repetitive)		T _j =150°C, 10ms	648	
Brake Chopper FWD	Collector-Emitter Voltage	V _{CES}		600	V
	Gate -Emitter Voltage	V _{GES}		± 20	
	Collector Current	I _C	Continuous	50	A
		I _{C PULSE}	1ms	100	
	Collector Power Dissipation	P _C	1 device	200	W
	Repetitive Peak Reverse Voltage	V _{RRM}		600	V
	Average Forward Current	I _{F(AV)}		1	A
	Surge Current	I _{FSM}	10ms	50	
	Operating Junction Temperature	T _j		+150	°C
	Storage Temperature	T _{Stg}		-40 ~ +125	
Isolation Voltage	V _{ISO}	A.C. 1min.	2500	V	
Mounting Screw Torque *1			1.7	Nm	

Note: *1:Recommendable Value; 1.3 ~ 1.7 Nm (M4)

■ Electrical Characteristics (T_j=25°C)

Items		Symbols	Test Conditions	Min.	Max.	Units	
Inverter	IGBT	Zero Gate Voltage Collector Current	I _{CES}	V _{GE} =0V V _{CE} =600V		1.0	mA
		Gate-Emitter Leakage Current	I _{GES}	V _{CE} =0V V _{GE} =±20V		20	μA
		Gate-Emitter Threshold Voltage	V _{GE(th)}	V _{GE} =20V I _C =50mA	4.5	7.5	V
		Collector-Emitter Saturation Voltage	V _{CE(sat)}	V _{GE} =15V I _C =50A		2.9	
		Input capacitance	C _{ies}	f=1MHz, V _{GE} =0V, V _{CE} =10V	3300 (typ.)		pF
	Turn-on Time	t _{on}	V _{CC} = 300V		1.2	μs	
		t _r	I _C = 50A		0.6		
		Turn-off Time	t _{off}	V _{GE} = ±15V			1.0
			t _f	R _G = 51Ω			0.35
	FWD	Diode Forward On-Voltage	V _F	I _F =50A V _{GE} =0V		3.1	V
Reverse Recovery Time		t _{rr}	I _F =50A		350	ns	
Rectif.	Forward Voltage	V _{FM}	I _F = 50A		1.55	V	
	Reverse Current	I _{RRM}	V _R =800V		1.0	mA	
Brake Chopper	IGBT	Zero Gate Voltage Collector Current	I _{CES}	V _{GE} =0V V _{CE} =600V		1.0	mA
		Gate-Emitter Leakage Current	I _{GES}	V _{CE} =0V V _{GE} =±20V		100	nA
		Collector-Emitter Saturation Voltage	V _{CE(sat)}	V _{GE} =15V I _C =50A		2.8	V
		Turn-on Time	t _{on}	V _{CC} = 300V		0.8	μs
			t _r	I _C = 50A		0.6	
	Turn-off Time	t _{off}	V _{GE} = ±15V		1.0		
		t _f	R _G = 51Ω		0.35		
FWD	Reverse Current	I _{RRM}	V _R =600V		1.0	mA	
	Reverse Recovery Time	t _{rr}			600	ns	

■ Thermal Characteristics

Items	Symbols	Test Conditions	Min.	Max.	Units
Thermal Resistance (1 device)	R _{th(j-c)}	Inverter IGBT		0.63	°C/W
		Inverter FRD		1.60	
		Brake IGBT		0.63	
		Converter Diode		2.10	
Contact Thermal Resistance	R _{th(c-f)}	With Thermal Compound	0.05 (typ.)		

Collector current vs. Collector-Emitter voltage
 $T_j=25^\circ\text{C}$

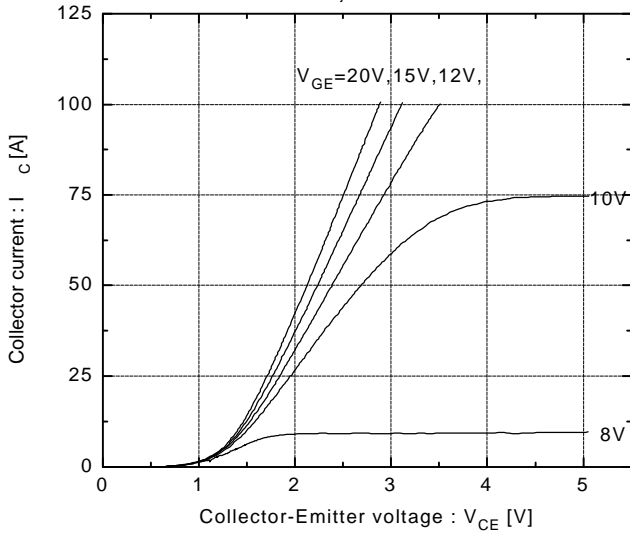

Collector current vs. Collector-Emitter voltage
 $T_j=125^\circ\text{C}$

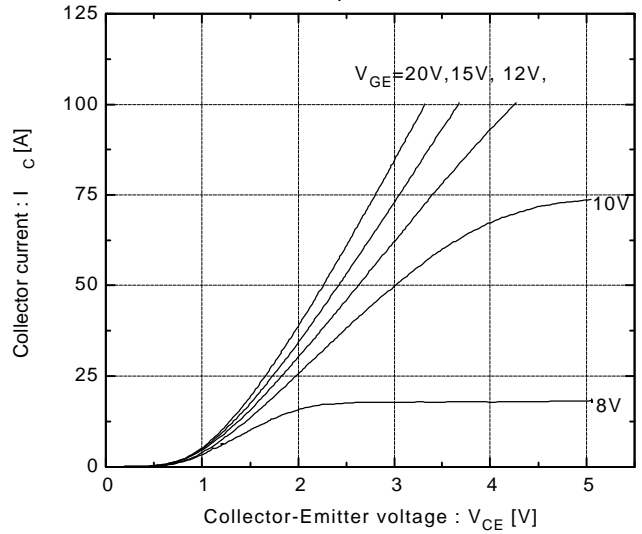

Collector-Emitter vs. Gate-Emitter voltage
 $T_j=25^\circ\text{C}$

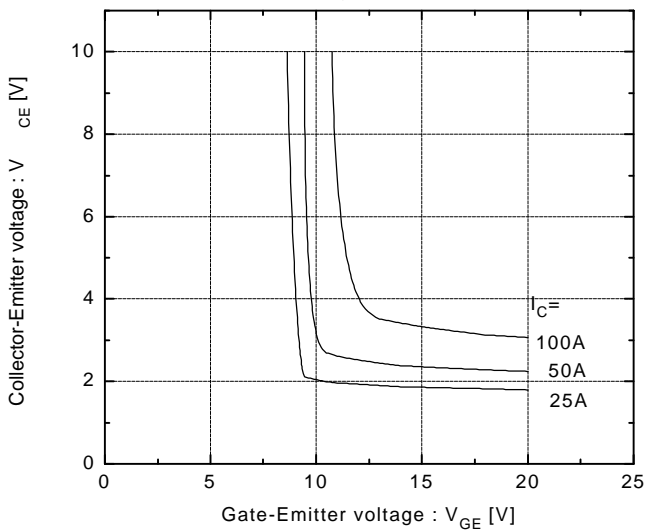

Collector-Emitter vs. Gate-Emitter voltage
 $T_j=125^\circ\text{C}$

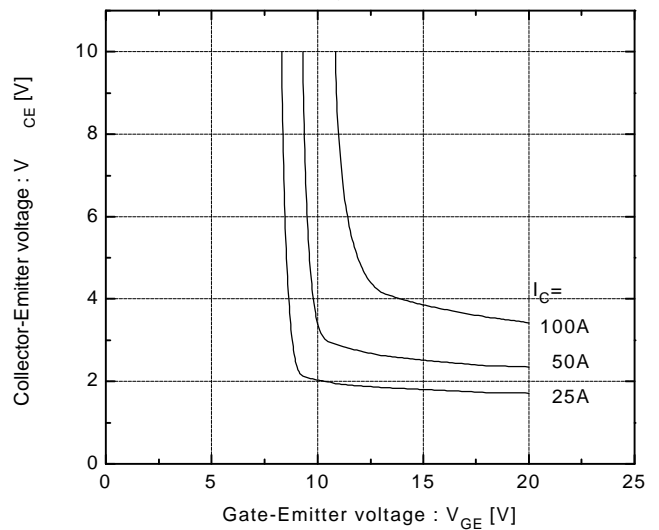

Switching time vs. Collector current
 $V_{CC}=300\text{V}, R_G=51\Omega, V_{GE}=\pm 15\text{V}, T_j=25^\circ\text{C}$

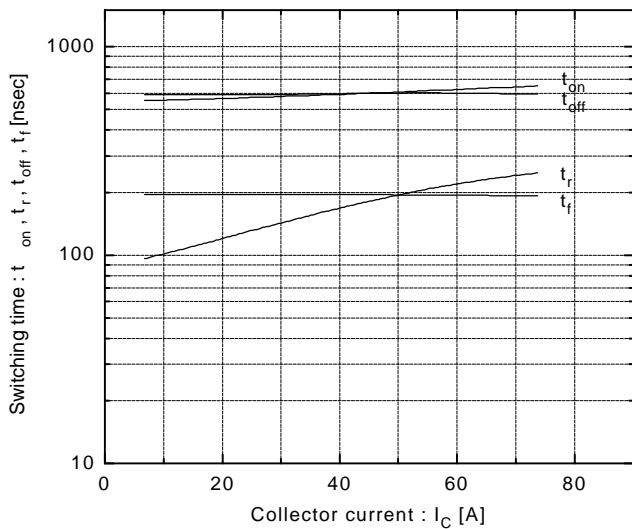

Switching time vs. Collector current
 $V_{CC}=300\text{V}, R_G=51\Omega, V_{GE}=\pm 15\text{V}, T_j=125^\circ\text{C}$

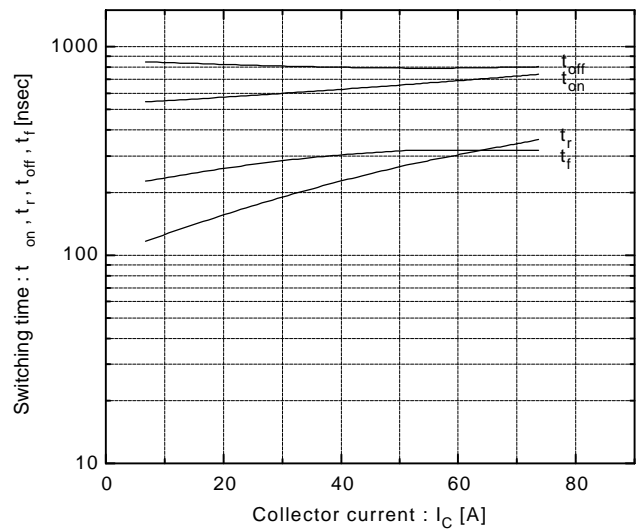

Switching time vs. R_G

$V_{CC}=300V, I_C=30A, V_{GE}=\pm 15V, T_J=25^\circ C$

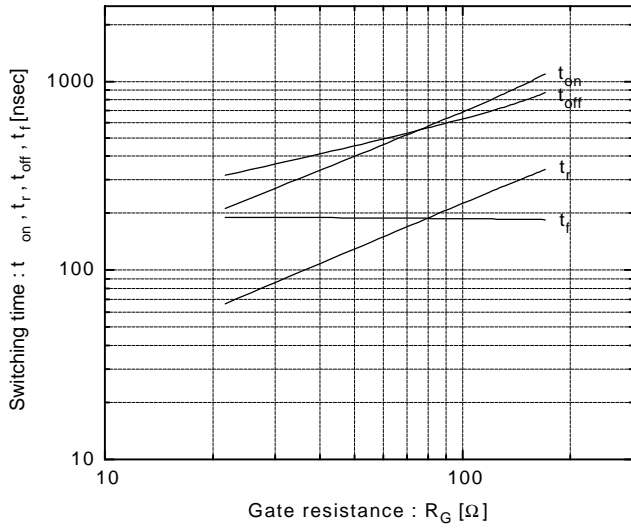

Dynamic input characteristics

$T_J=25^\circ C$

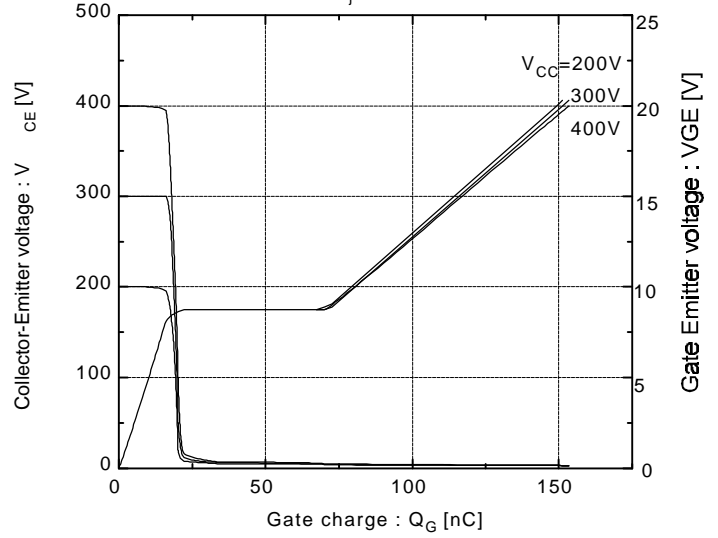

FRD

Forward current vs. Forward voltage

$V_{GE}=0V$

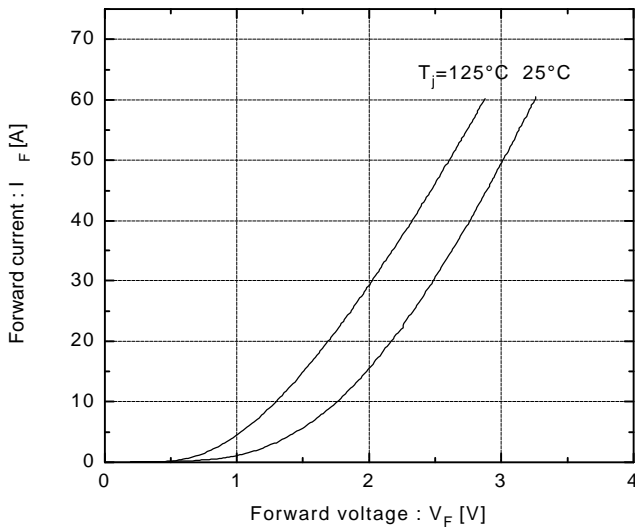

Reverse recovery characteristics

t_{rr}, I_{rr} vs. I_F

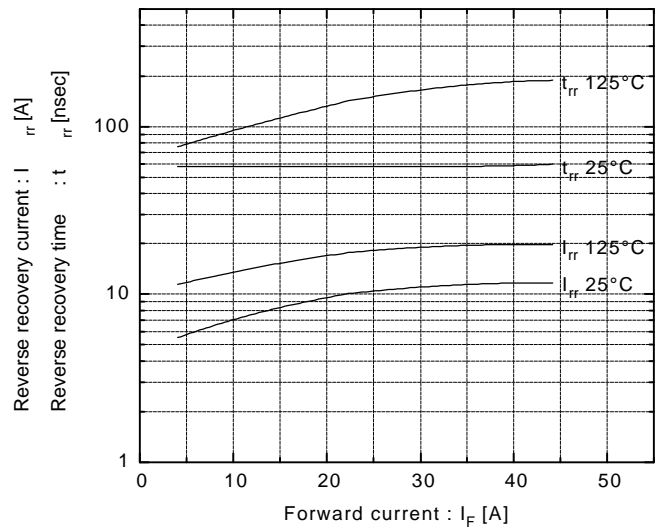

Transient thermal resistance

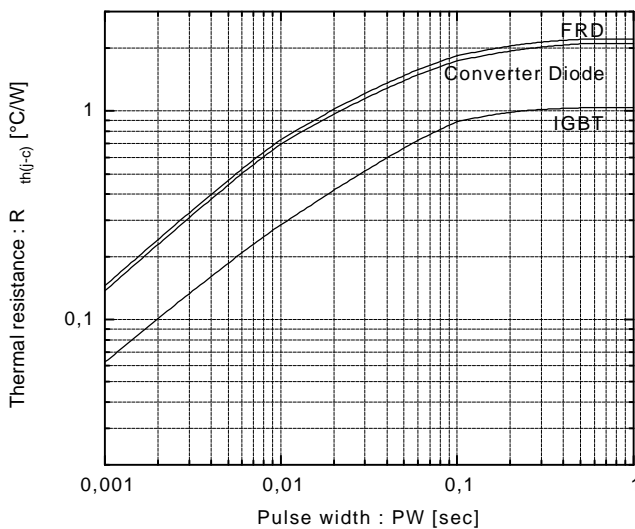

Reversed biased safe operating area

$+V_{GE}=15V, -V_{GE}\leq 15V, T_J\leq 125^\circ C, R_G\geq 82\Omega$

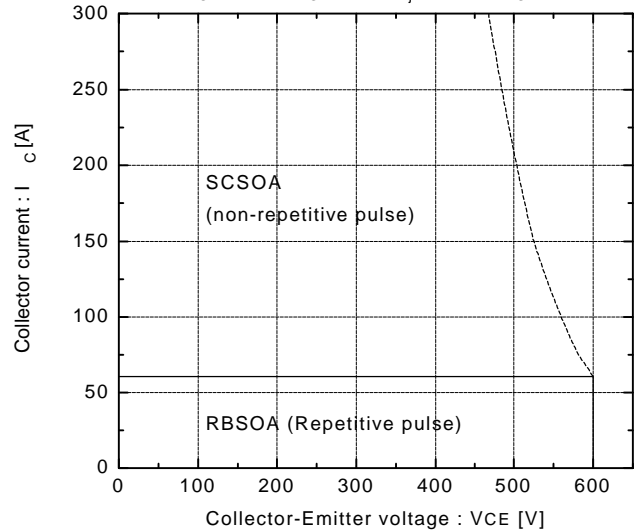

Switching loss vs. Collector current
 $V_{CC}=300V, R_G=51\Omega, V_{GE}=\pm 15V$

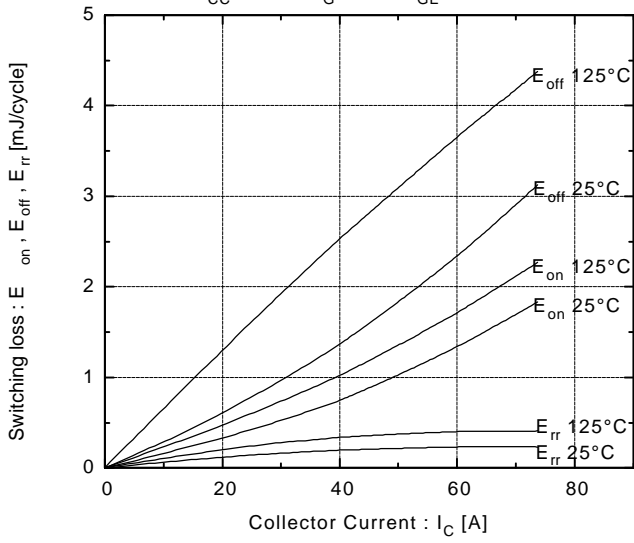

Capacitance vs. Collector-Emitter voltage
 $T_j=25^\circ C$

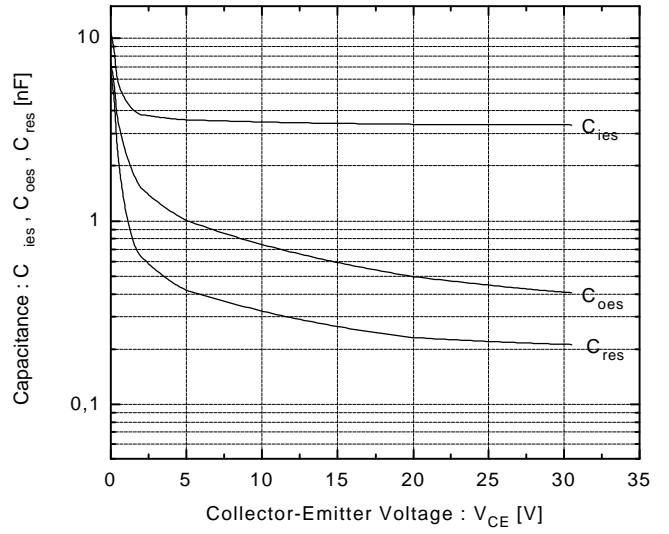

Converter Diode
 Forward current vs. Forward voltage
 $V_{GE}=0V$

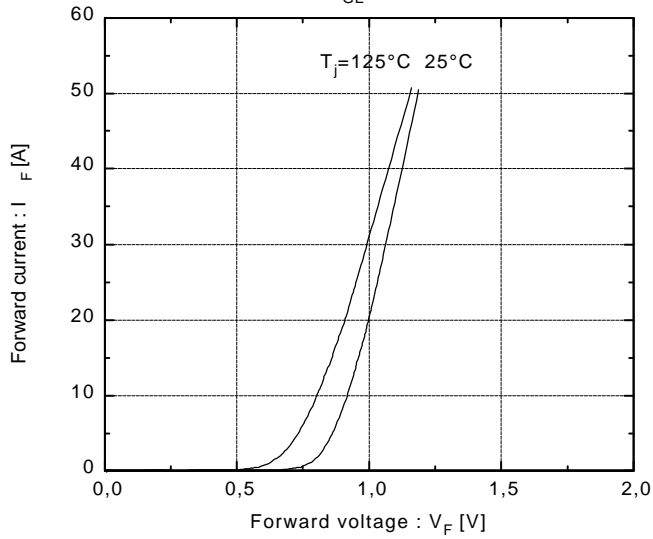

Brake Chopper IGBT

Collector current vs. Collector-Emittor voltage

$T_j=25^\circ\text{C}$

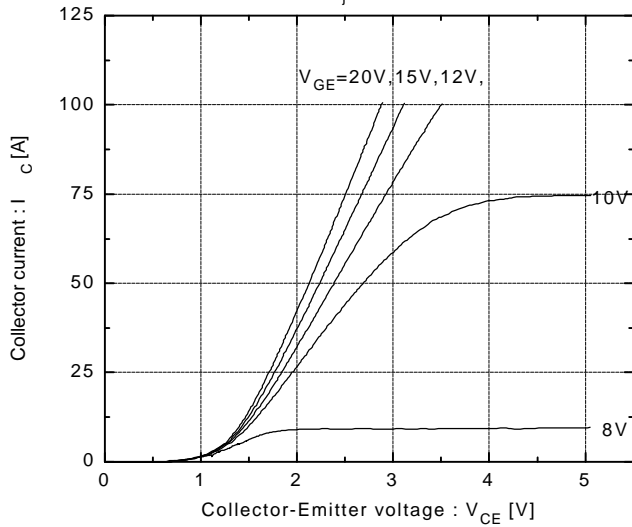

Collector current vs. Collector-Emittor voltage

$T_j=125^\circ\text{C}$

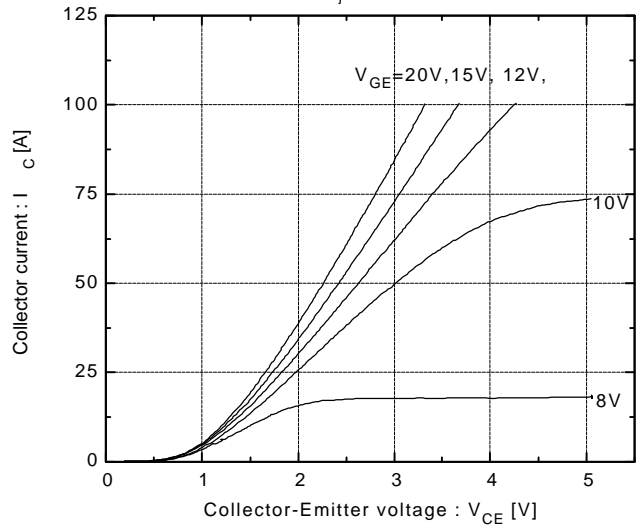

Collector-Emittor vs. Gate-Emittor voltage

$T_j=25^\circ\text{C}$

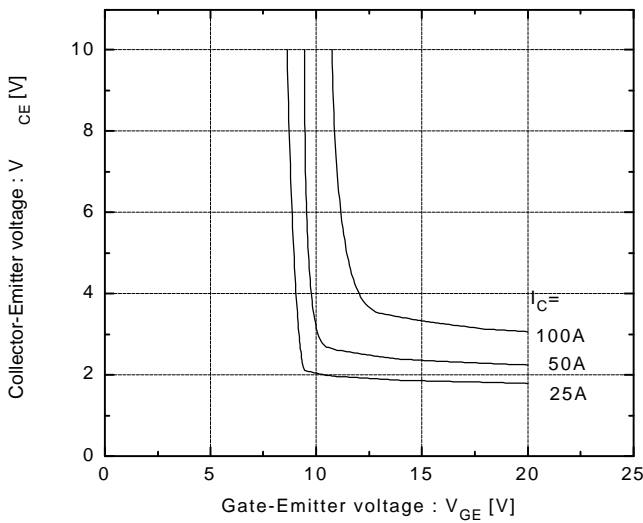

Collector-Emittor vs. Gate-Emittor voltage

$T_j=125^\circ\text{C}$

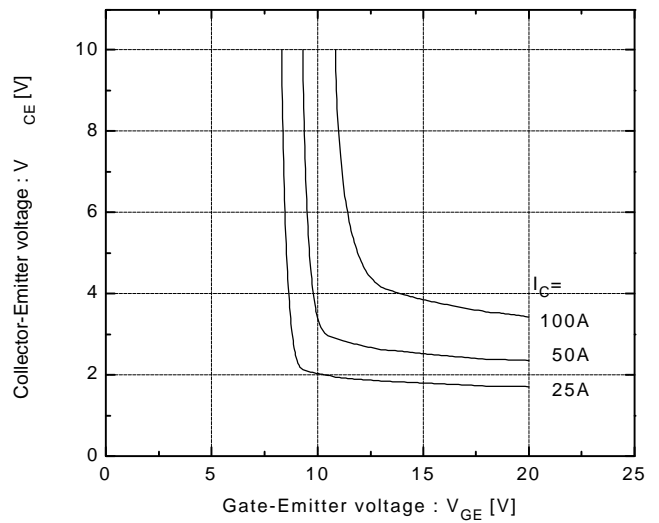

Switching time vs. Collector current

$V_{CC}=300\text{V}, R_G=51\Omega, V_{GE}=\pm 15\text{V}, T_j=25^\circ\text{C}$

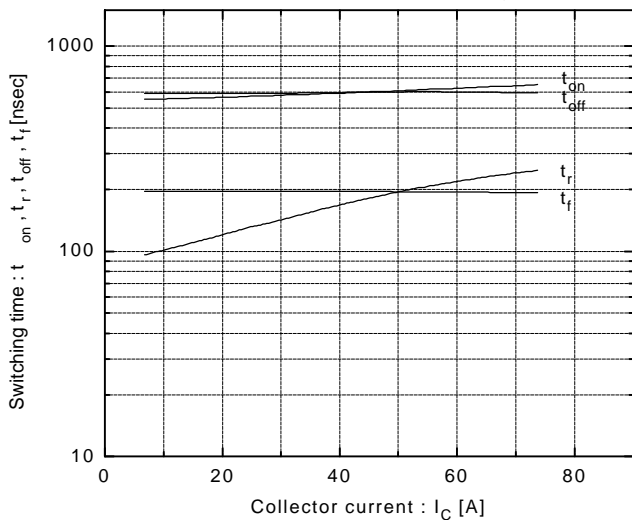

Switching time vs. Collector current

$V_{CC}=300\text{V}, R_G=51\Omega, V_{GE}=\pm 15\text{V}, T_j=125^\circ\text{C}$

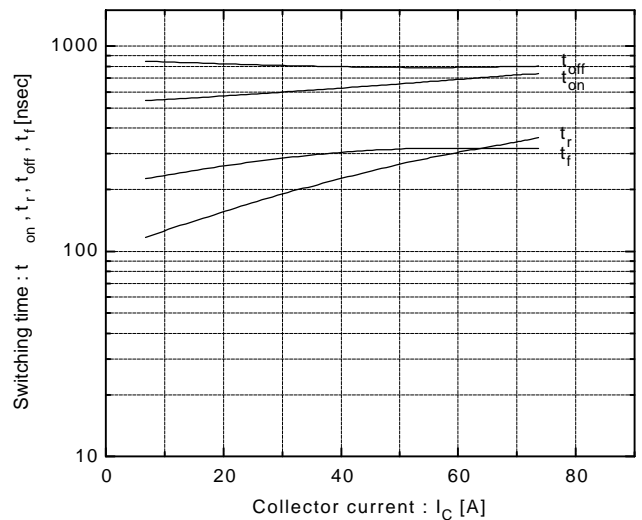

Brake Chopper IGBT

